

## BAD PRACTICE 不良作业方式

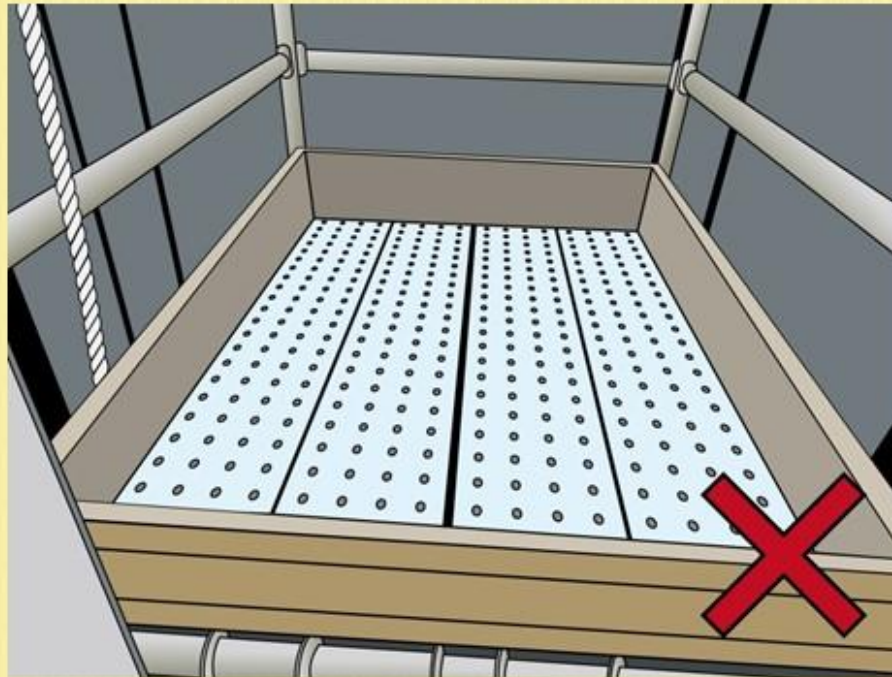

**No stairs / ladders were observed as the safe means of access and egress to the lift pit.**

没有提供安全的楼梯/梯子进出升降机槽底。

## BAD PRACTICE 不良作业方式

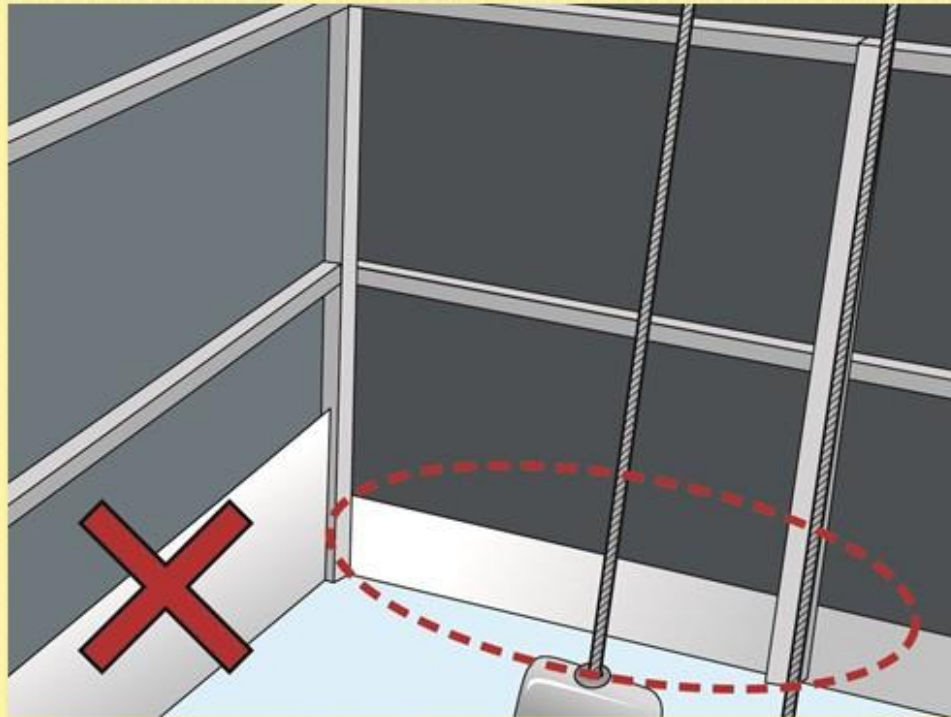

A portion of toe-board was found not up to the required 200MM height

部分踢脚板发现不够所需的200MM高度。

## BAD PRACTICE 不良作业方式

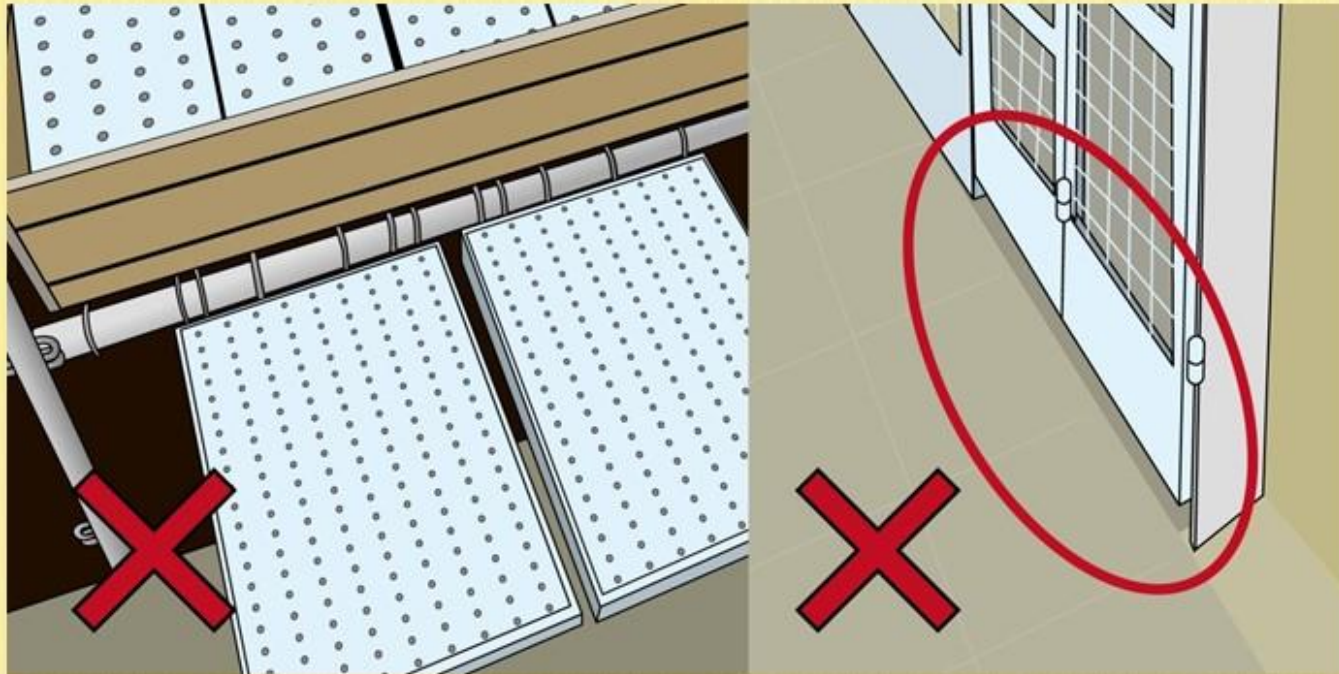

**Gaps were found at the access and the toeboard of the gate - room to improvement**

通道及踢脚板上发现空隙



## BAD PRACTICE 不良作业方式

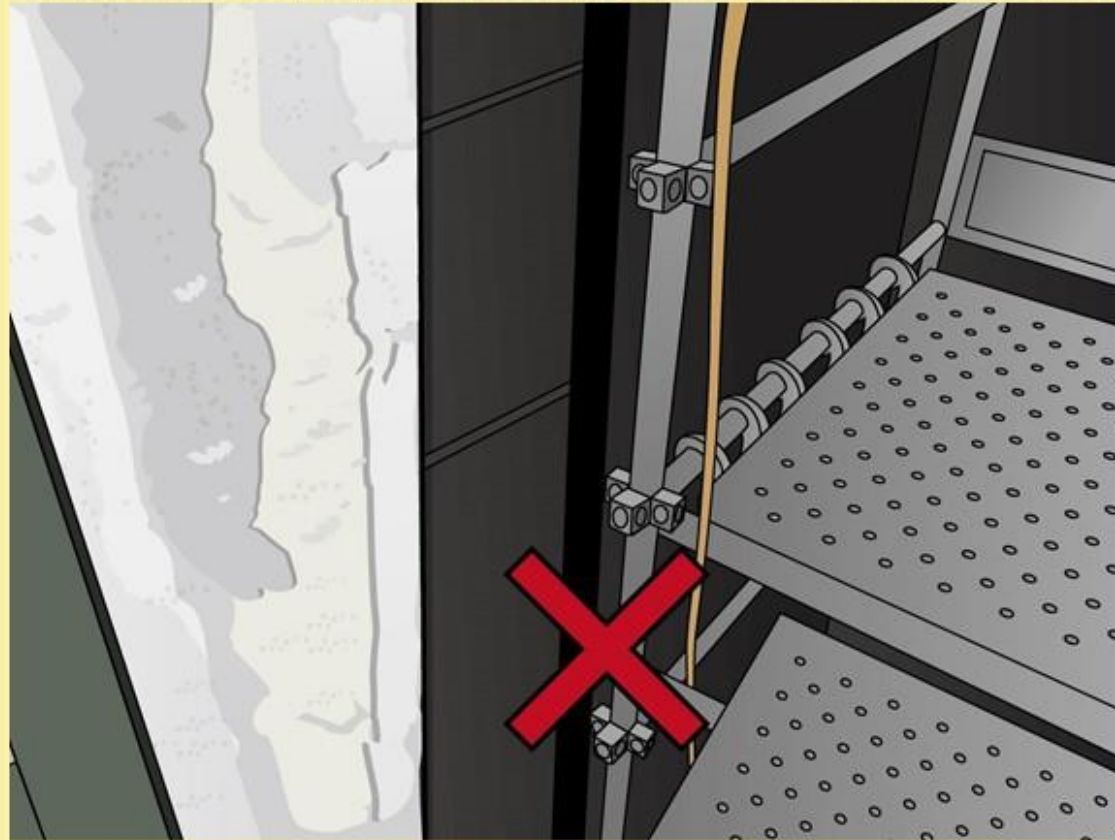

Dangerous edge was not guarded and toeboard was found missing 危险的边缘未有保护好及没有踢脚板

## BAD PRACTICE 不良作业方式

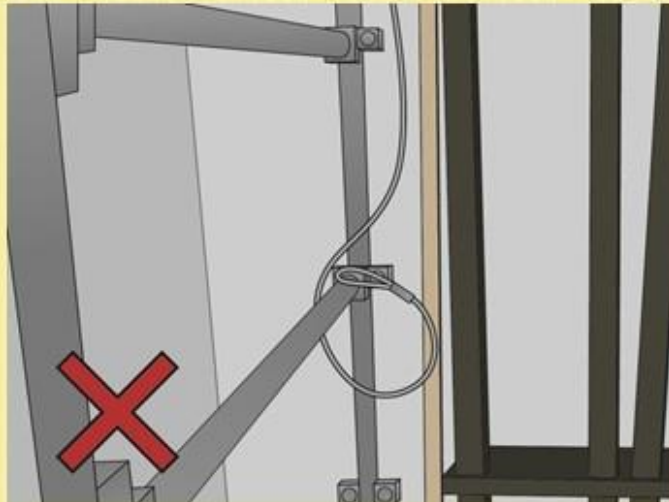

Wire sling was found without colour code 吊索被发现没有喷上颜色代码。



Independent life line provided at lift shaft. However, the loading capacity should be further checked and confirmed to meet the COP requirement 虽然升降机槽已提供独立救生绳，但承载能力应进一步检查和确认。

## BAD PRACTICE 不良作业方式



Materials should be cleared off  
in the public area 物料不应该  
堆放在公共区域

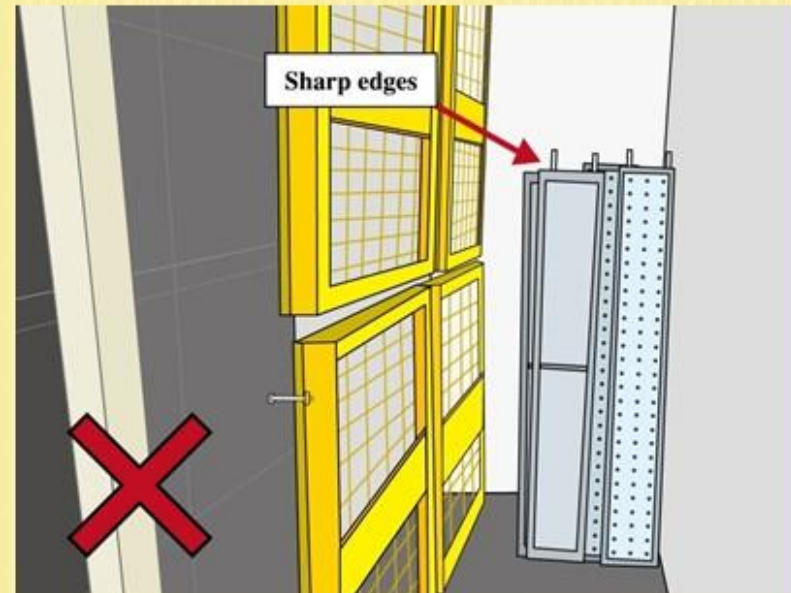

Stored materials were not fixed  
properly.  
不安全的物料堆放



## BAD PRACTICE 不良作业方式

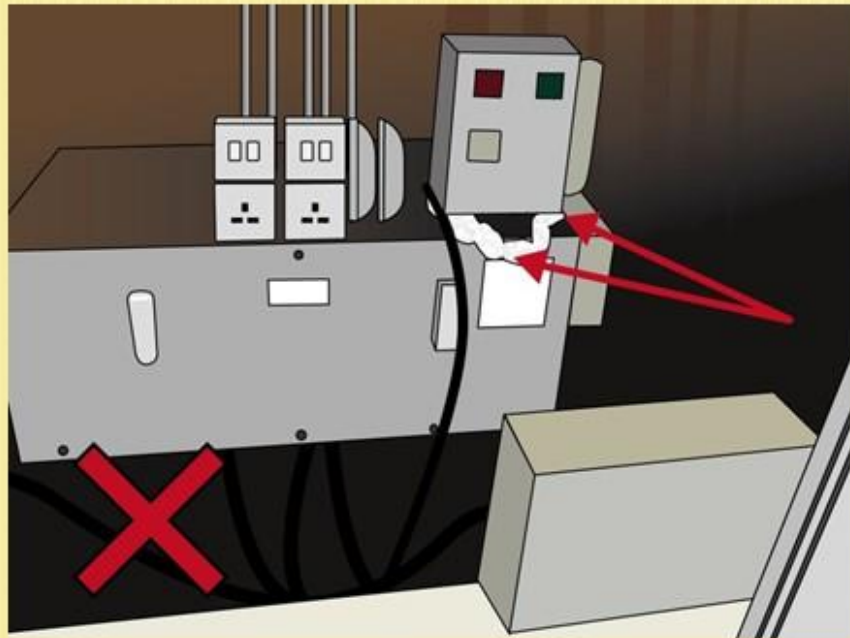

Improper waste disposal on top of the lift car was observed 电梯轿厢的顶部有废物堆放。

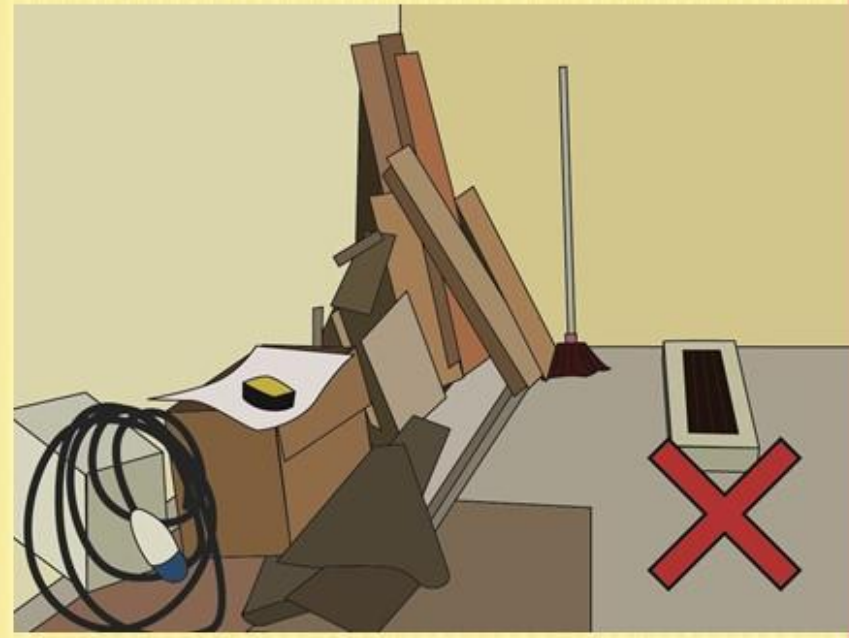

Construction materials should be stored properly in the machine room 在机房施工材料应妥善保存。

## BAD PRACTICE 不良作业方式

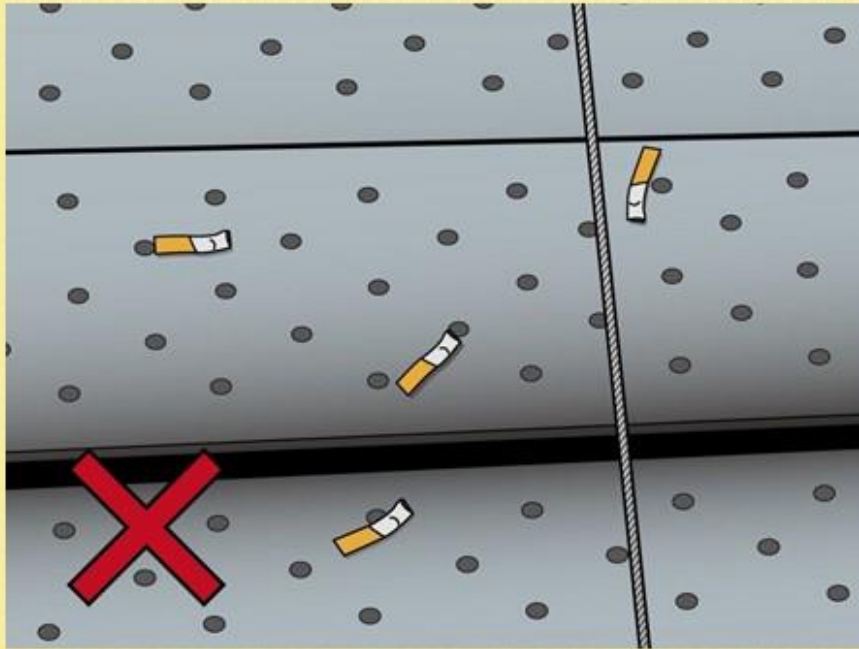

Cigarette ends in workplace  
在工作场所弃置烟蒂



Sharp edges of H-beams in lift machine  
room should be adequately protected.  
在电梯机房的锋利的边缘应得到充分保护。



## BAD PRACTICE 不良作业方式



**The bonding line should be maintained in a good condition** 接合线应保持在良好状态

## BAD PRACTICE 不良作业方式

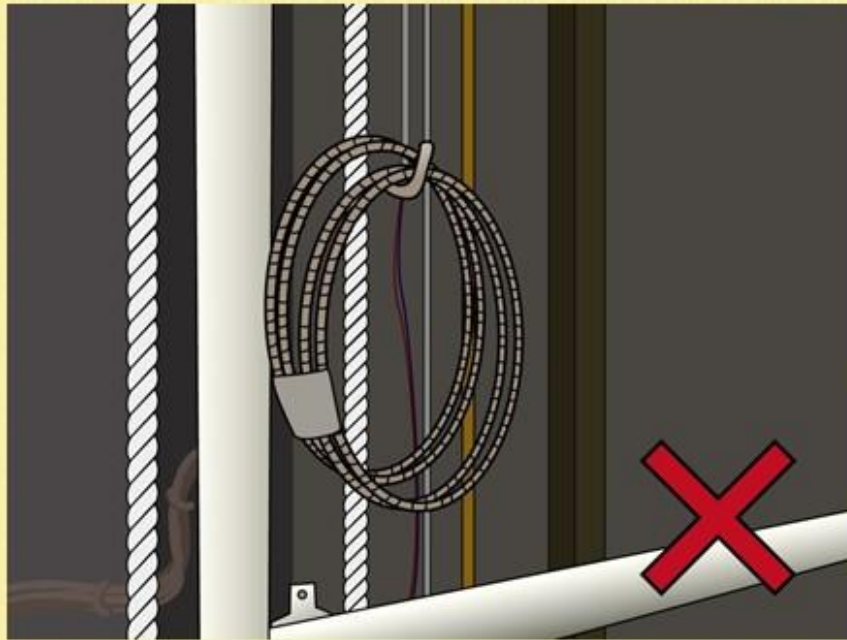

Lifting gear inside the lift shaft did not have proper colour code

升降机槽内的起重装置欠缺颜色代码

## BAD PRACTICE 不良作业方式

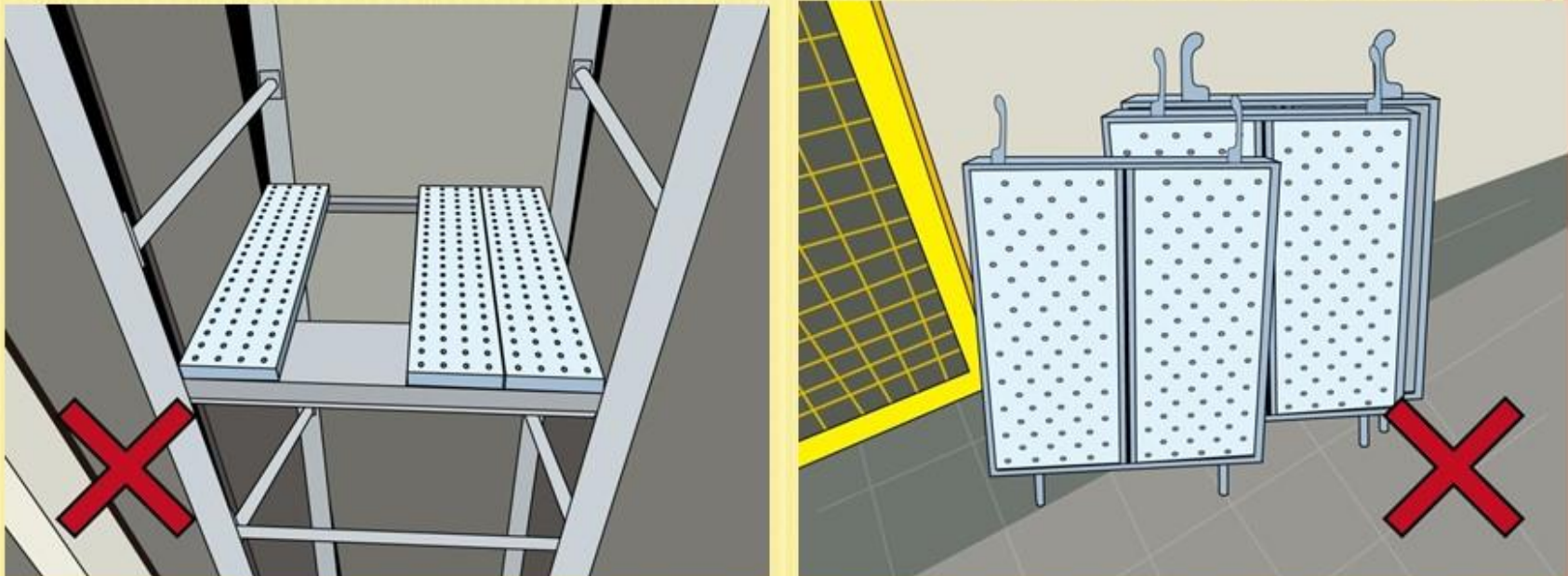

Working platform of the metal scaffold inside the lift shaft was not provided with full set of planking / toe-boards / guard-rails 未有装好地台板/ 踢脚板/ 安全围栏的工作平台



## BAD PRACTICE 不良作业方式

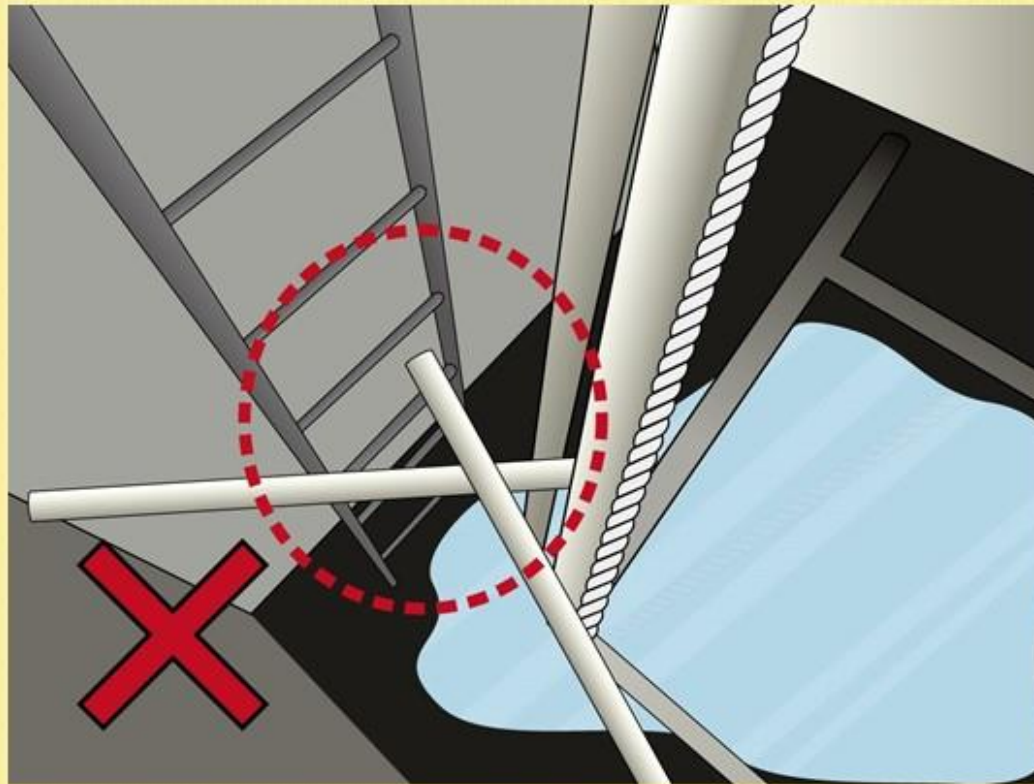

Cat-ladder was obstructed by the tieback. Stagnant water was observed in the lift pit

爬梯(猫梯)被系杆阻塞, 升降机槽底部有积水

## BAD PRACTICE 不良作业方式



Substandard Lanyard of Safety Harness  
防墮裝置(安全帶防墮扣)未有保養好

## BAD PRACTICE 不良作业方式

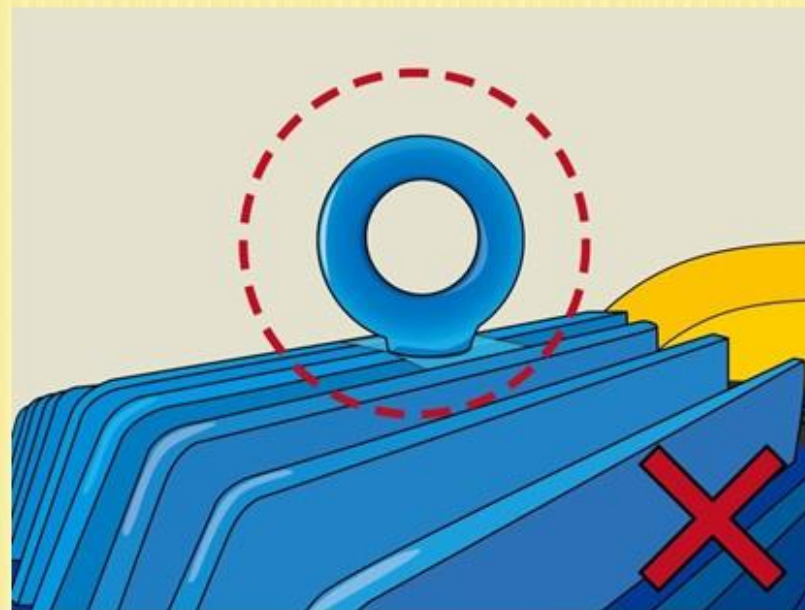
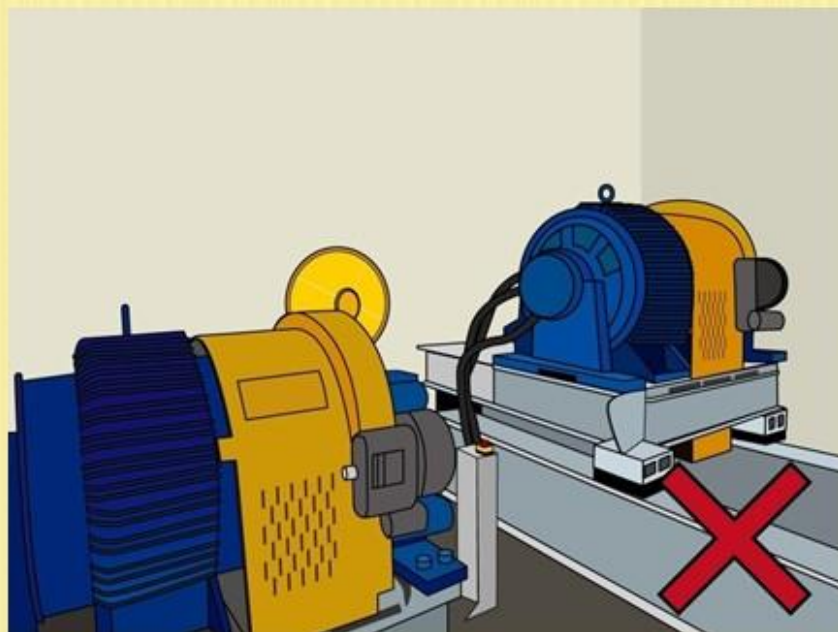

Unable to present the test certificate of the lifting eye during the audit verification on site 未能出示防坠装置锚固点的检验证书



## BAD PRACTICE 不良作业方式



Poor Housekeeping at the access  
升降机槽出入口欠妥善整理

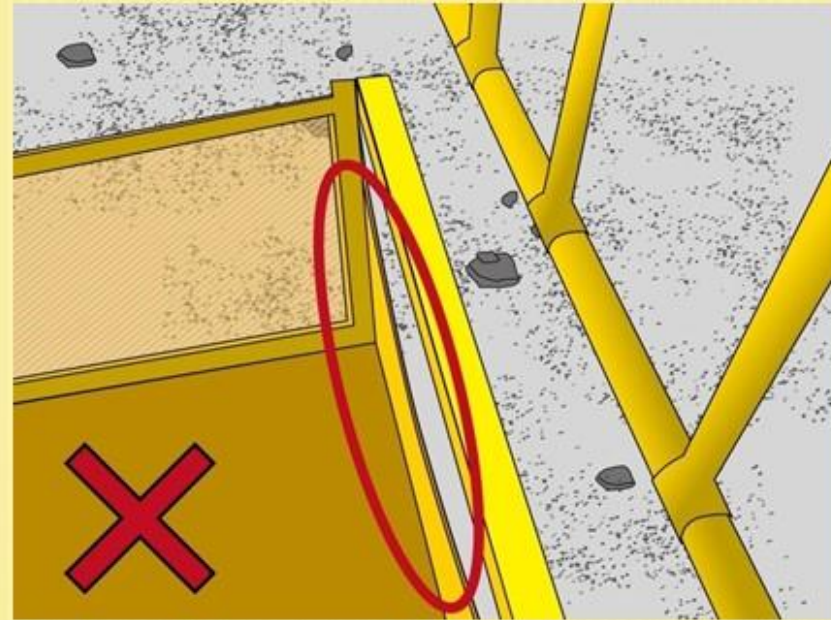

Improper Protection of Sharp Material  
锋利物料保护不当

## BAD PRACTICE 不良作业方式

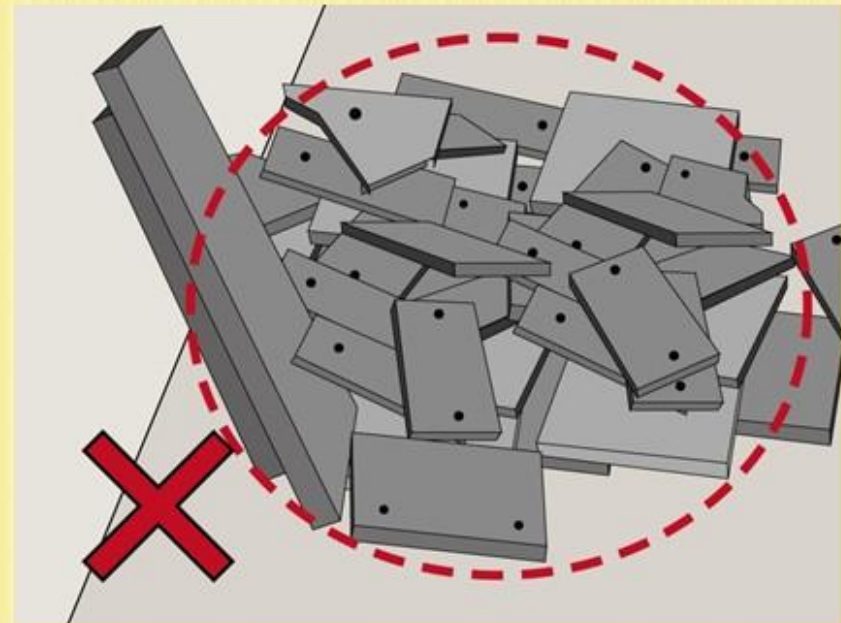
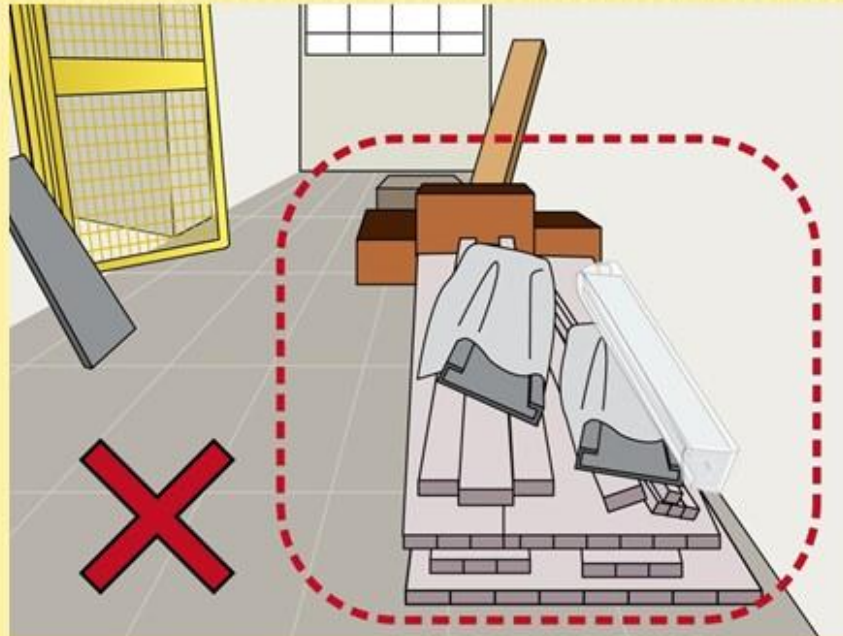

Workplace was not Maintained in Good Condition

- 1) add barrier to separate the storage area
- 2) container should be provided to store small objects

工地设施欠妥善整理

- 1)使用围栏分隔物料储存区域
- 2)提供存箱子储较小的物料



## BAD PRACTICE 不良作业方式



In-running roller have gap with proper protection 运行中滚轴有缝隙，保护不当

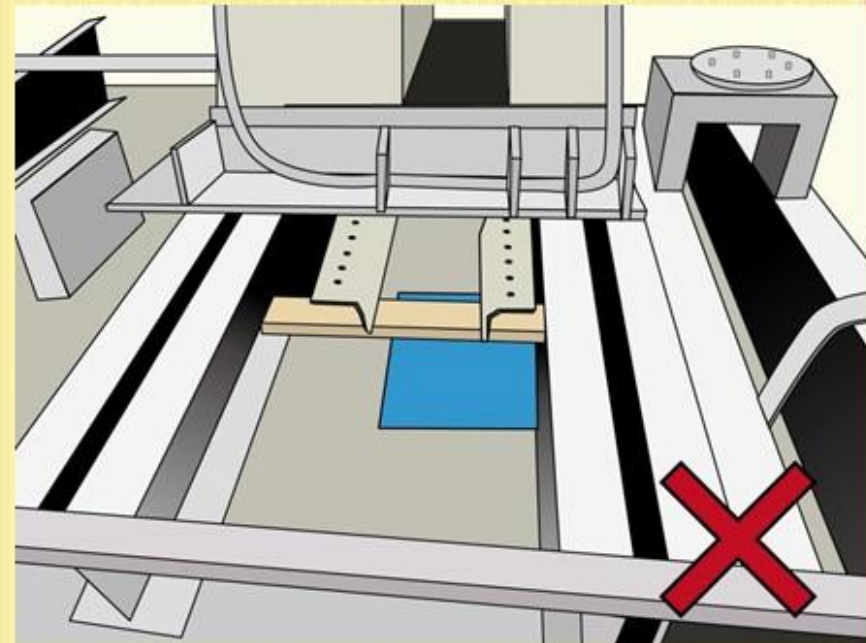

The small openings should be protected by the timber plates instead of the polyfoam

开口保护不当，应用较坚固料盖好



## BAD PRACTICE 不良作业方式

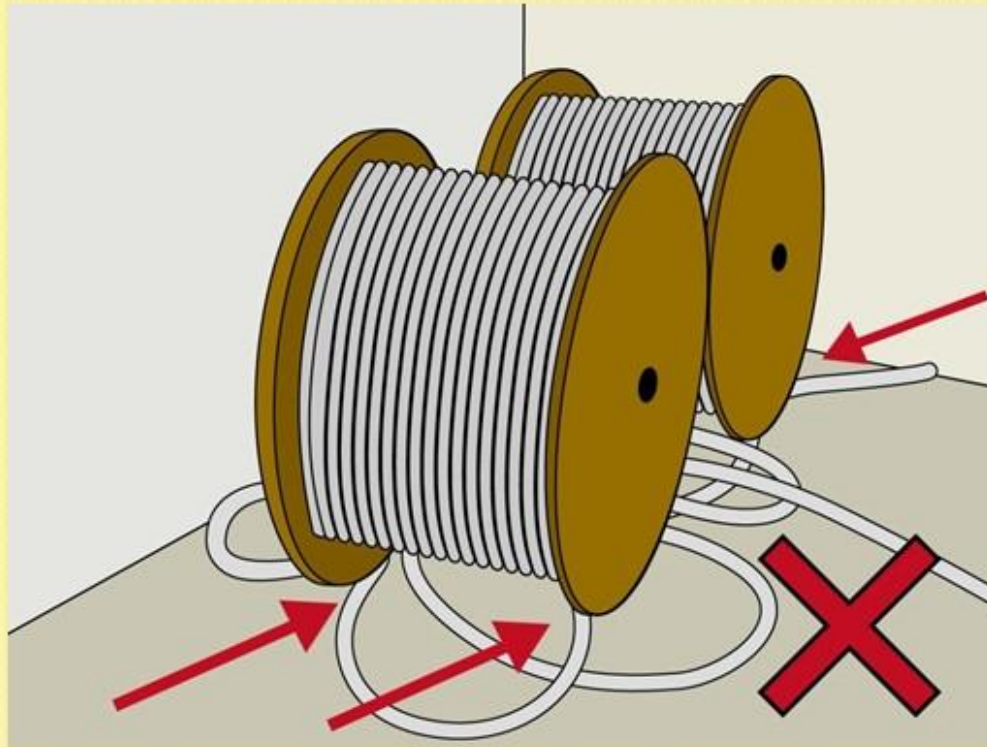

Improper Wedge of Cable Drums  
电缆滚筒欠妥善整理

## BAD PRACTICE 不良作业方式



Improper Guarding on Electrical Winch  
电器绞盘保护不当

## BAD PRACTICE

- Working platform was not provided together with full set of planking / toe-boards / guard-rails in the metal scaffold inside the lift shaft
- 未有装好工作平台的地台板/ 踢脚板/ 安全围栏

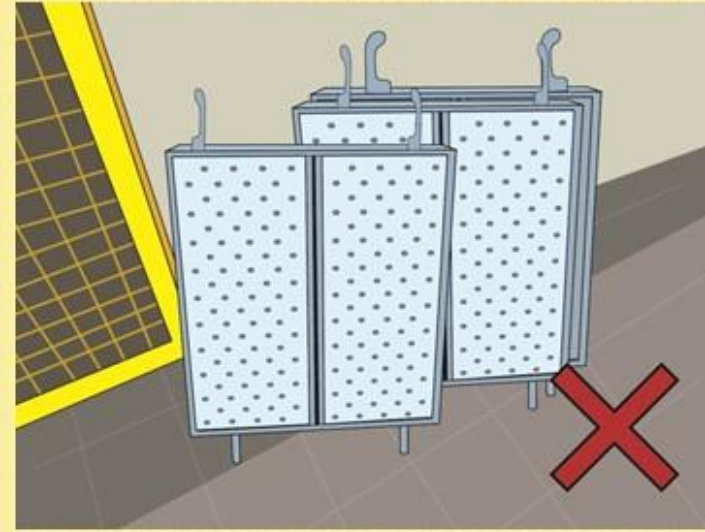
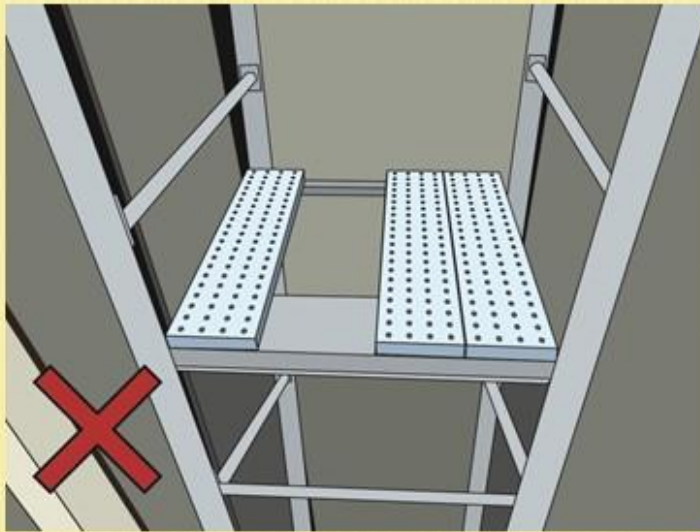



## BAD PRACTICE

- Cat-ladder was obstructed by the tieback, stagnant water was observed in the lift pit
- 爬梯(猫梯)被回接管阻塞, 电梯槽底部有积水

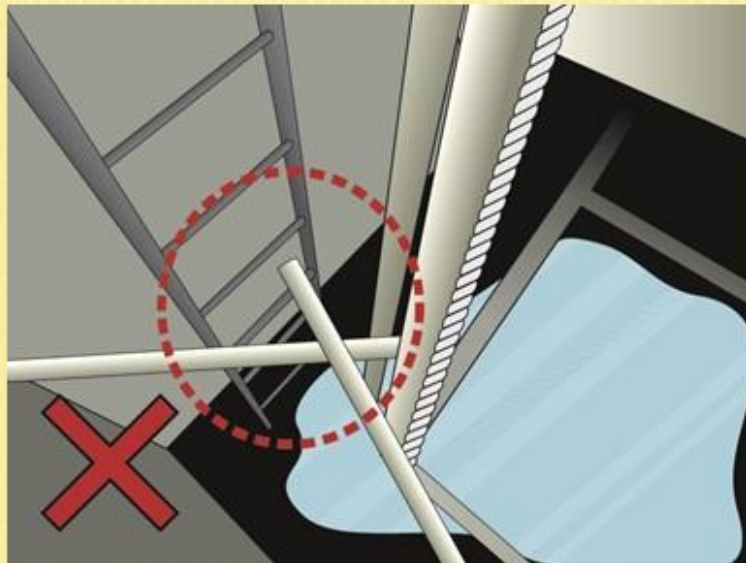

## BAD PRACTICE

- Improper working platform
- 不当工作台



## BAD PRACTICE

- Poor housekeeping at the access
- 升降机槽出入口欠妥善整理





## BAD PRACTICE

- Inadequate protective guard to the in-running roller
- 运行中滚轴有缝隙，保护不当

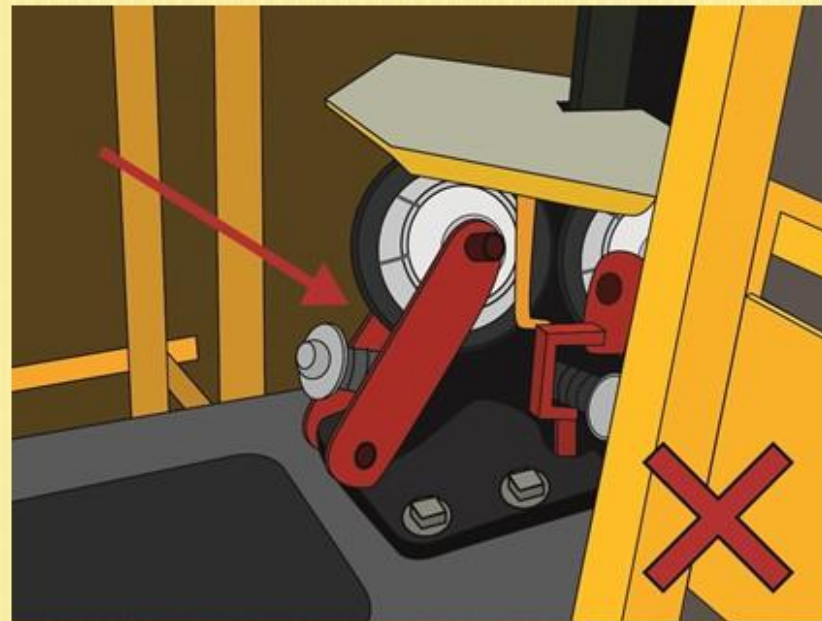

## BAD PRACTICE

- Water contained in lift shaft
- 升降机槽内有积水

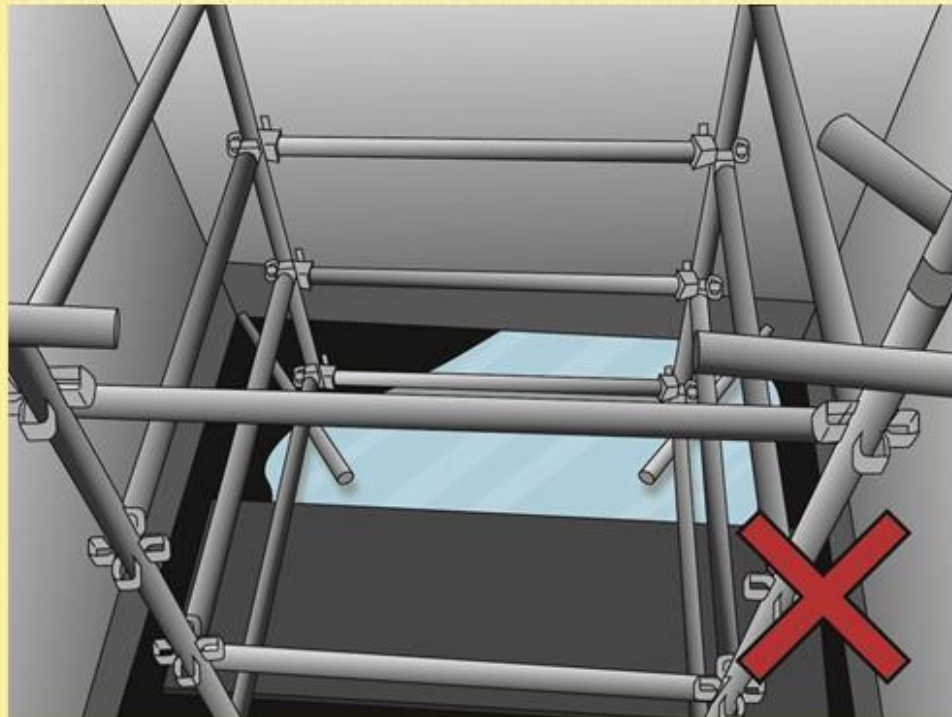

## BAD PRACTICE

- Damaged electrical connector
- 损坏的接头

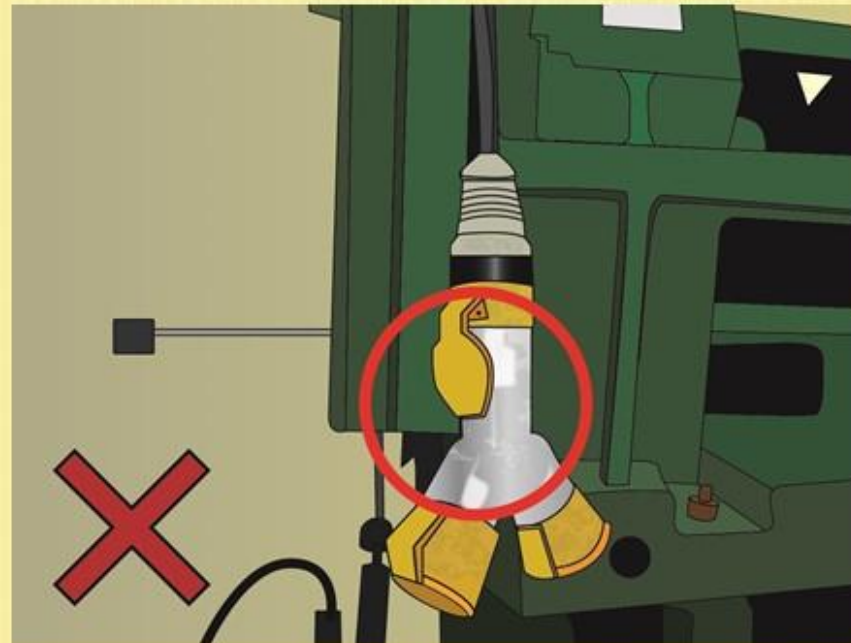



## BAD PRACTICE

- Unsafe access to working platform
- 不安全进出口

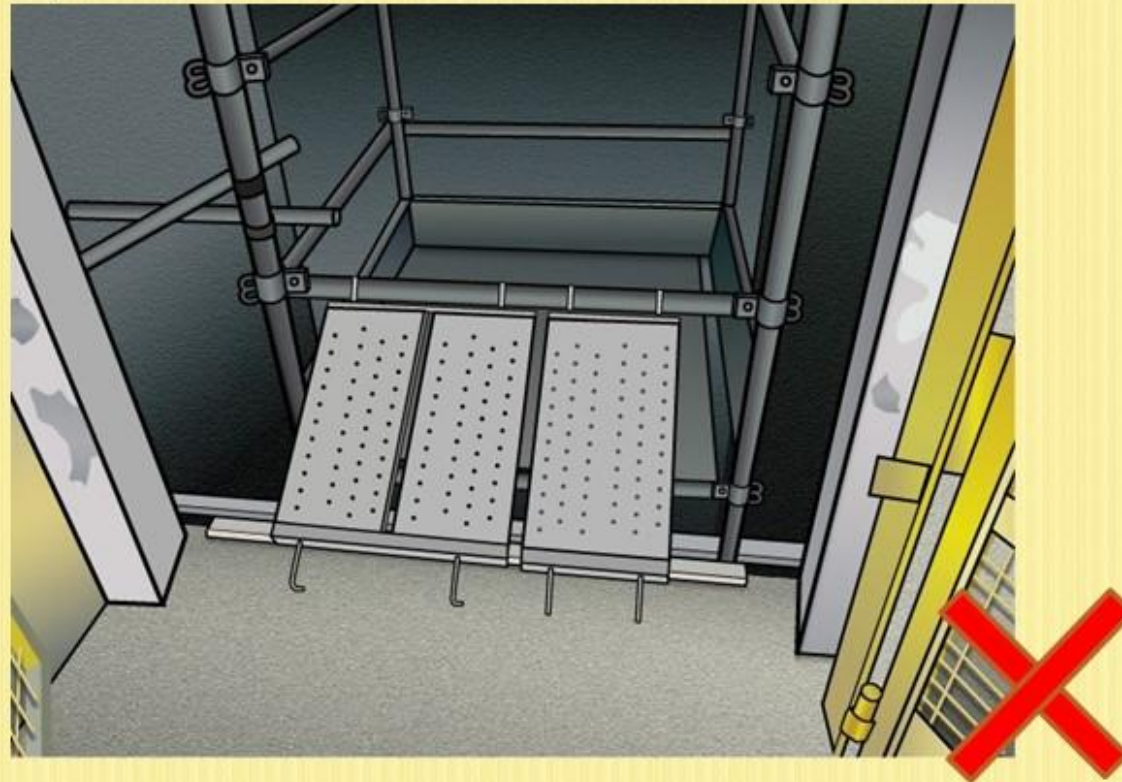

## BAD PRACTICE

- Floor opening was not protected
- 地洞没有覆盖



## BAD PRACTICE

- Materials stacked at high level
- 物料存放于高处

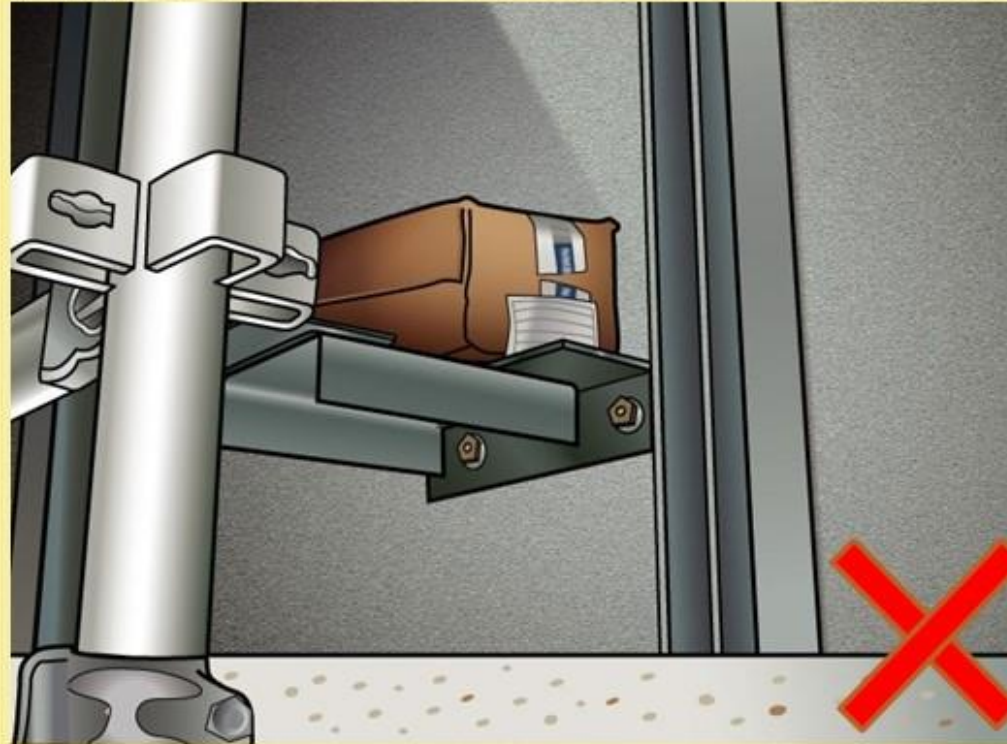



## BAD PRACTICE 不良作业方式

- Absence of mid-rail in the metal scaffold
- 金属棚架没有中围栏



## BAD PRACTICE 不良作业方式

- Absence of top guard-rail in the metal scaffold
- 金属棚架没有高围栏



## BAD PRACTICE 不良作业方式

- Hanging block was installed on the metal scaffold
- 安装链滑车在金属棚架

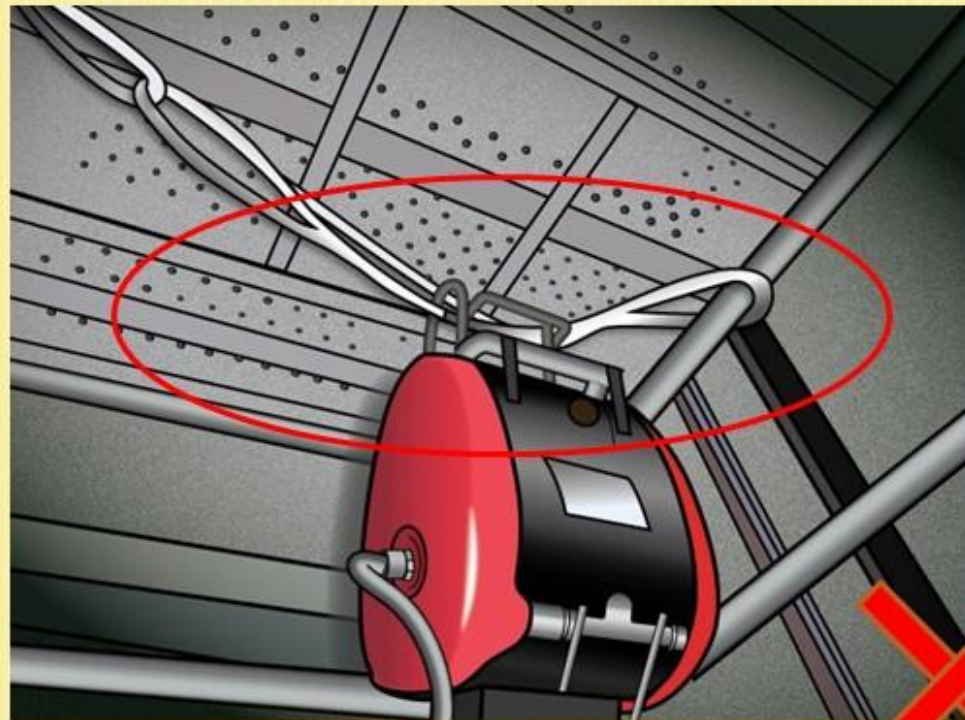



## BAD PRACTICE不良作业方式

- Improper guarding for electric winch
- 电动绞机的危险部份没有完全隔开

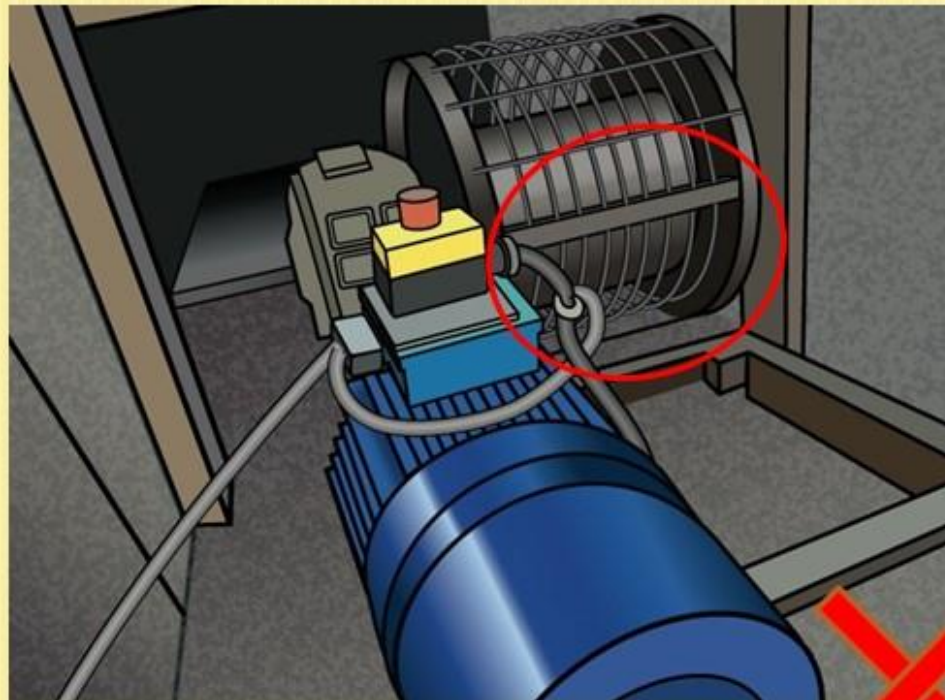

## BAD PRACTICE 不良作业方式

- Material left at high level
- 物料留高处

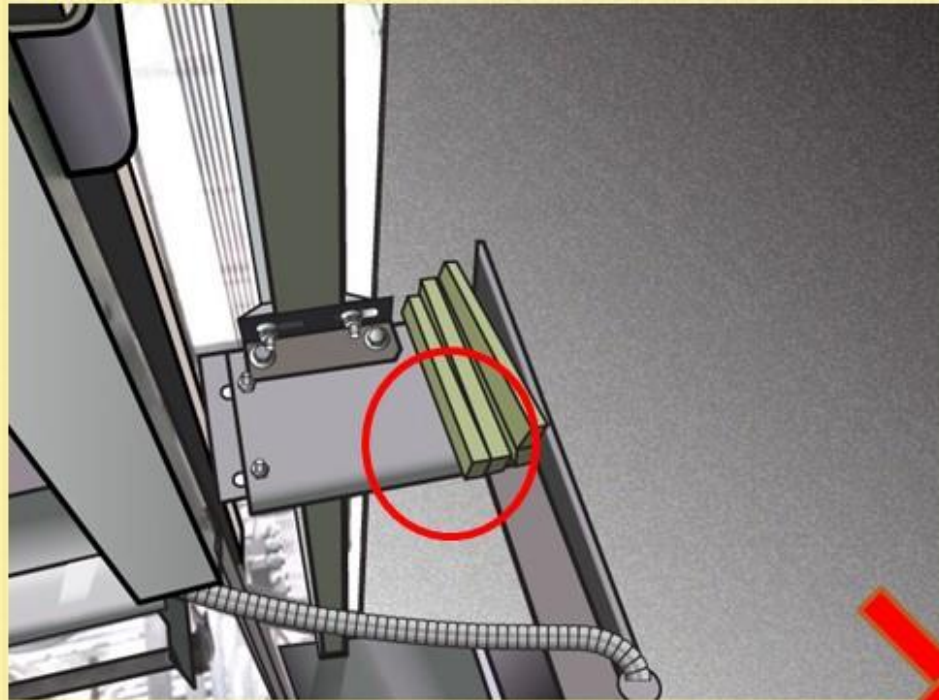

## BAD PRACTICE 不良作业方式

- The access was obstructed by the accumulated rubbish
- 通道被堆积的垃圾阻塞





## BAD PRACTICE 不良作业方式

- Floor edge without fencing in lift shaft
- 未有在临边位置安装围栏



## BAD PRACTICE 不良作业方式

- Electric cable laid on ground floor and invalid cable connector used at work
- 电线没有挂高及使用不恰当的电缆连接器

